

DEUBLIN®

A Member of the HOERBIGER Group

Company information

| | |
|--------------------------------|---|
| <i>DEUBLIN</i> philosophy | 2 |
| Reliability / Service / Repair | 3 |

Technical information

| | |
|---|-----|
| Sealing / Manufacturing | 4 |
| Which <i>DEUBLIN</i> Seal Technology? | 5 |
| Operating Principles of Rotating Unions | 6-9 |

Installation guide

| | |
|--|-------|
| Instruction for Hose Installation and Assembly | 10 |
| The position of the supply lines and drainage | 11 |
| Correct installation extends service life / part 1 | 12-13 |
| Correct installation extends service life / part 2 | 14-15 |

Printing industry

| | |
|---|-------|
| Contemporary rotating unions for modern printing machines | 16-17 |
|---|-------|

Plastics industry

| | |
|--------------------------------------|-------|
| Rotating unions on plastics machines | 18-19 |
|--------------------------------------|-------|

Wind power industry

| | |
|---|-------|
| High-pressure hydraulic rotating unions for wind turbines | 20-21 |
|---|-------|

Coil winding industry

| | |
|--|-------|
| Rotating unions in the coil winding sector | 22-23 |
|--|-------|

Paper industry

| | |
|---|----|
| The new CK series rotating union has done an excellent job! | 24 |
|---|----|

Certifications

| | |
|---|----|
| Rotating Unions with ATEX Certification | 25 |
| <i>DEUBLIN</i> AEO F Certification | 25 |

Service and Support

| | |
|---|----|
| DPS – <i>DEUBLIN</i> Performance System | 26 |
| Trainings, Seminars, Workshops ect. | 26 |
| Catalogues, <i>DEUBLIN</i> worldwide | 27 |

IN-Sight

Our aim: "To make every effort toward producing the best product of its kind on the Market".

This tenet serves as an incentive and an obligation in equal measure. Adherence to this policy has been responsible for our growth from a small garage shop to the world's largest manufacturer of Rotating Unions with a world-wide sales and service network.

Wherever water, steam, oil, coolant lubricants or other media have to be conveyed into or through turning machine parts, like rollers, shafts or spindles, rotating unions are employed in a wide range of industrial fields.

Developed in 1945, and continually improved as a result of practical requirements, **DEUBLIN** Rotating Unions are at the cutting edge of technology today.

DEUBLIN Rotating Unions – the industry standard. Our customers can rely on our engineering expertise, R&D capabilities, manufacturing techniques and more than 60 years of knowledge and experience.

Our product range is constantly being developed and expanded. In addition, we offer special solutions, customer specified variations and modular designs which enable us to provide users with the perfect solution for virtually any application.

Direct contact with customers and a close collaboration with the original equipment manufacturers provide the basis for continuous improvement.

Quality encompasses our entire enterprise.

At **DEUBLIN**, reliable products at competitive prices and just-on-time deliveries are standards.

This, of course, requires an integrated total quality control system that is practiced in all areas of our organisation.

Quality is the result of teamwork!



DEUBLIN has its Corporate Headquarter in Waukegan, USA. For over 30 years the facilities in Germany

and Italy have been producing for the European, African and Near Eastern Market.

Besides sales and warehouse facilities in almost every country in Europe, we also have company owned subsidiaries in Austria, Brazil, Canada, China, France, Germany, Italy, Japan, Mexico, Poland, Russia, Singapore, Spain, South Korea, Sweden and the United Kingdom.

Our customers can rely on our worldwide manufacturing and sales & service network.



Due to its Total Quality Management System **DEUBLIN** was awarded its initial Certification pursuant to DIN EN ISO 9001 in 1996 by the German Standard Institute. In October 2002 the re-certification followed accompanied by the initial Certification for its Environmental Management System pursuant to DIN EN ISO 14001.

Since March 2009 **DEUBLIN** is certified as Authorised Economic Operator (AEO), see page 25.

Thus **DEUBLIN** sets new standards.

Visit us at our interactive virtual FreeMove3D trade fair booths on

www.deublin.info.



Reliability

Years of experience, constant dialogues with customers, in-house and supplier innovations have enabled **DEUBLIN** to offer reliable rotating unions at the cutting edge of technology. The right seal combination compatible to the media guarantees the maximum service life for every particular application.

A clean and efficient warehousing and handling of the union is just as much a prerequisite for our customers as the adherence to the **DEUBLIN** specifications.

The market demands more products with a longer service life at more extreme parameters.

Besides new developments and the constant modification of existing products, it is above all better



wear-resistant seal combinations that accommodate these market demands. **DEUBLIN** offers these seal combinations under the designation E.L.S. (**Ex**-tended **L**ife **S**ealing).

Service

For **DEUBLIN** customer-orientated service means: customisation and/or newly engineered unions for special requirements, an all-encompassing technical consultation by union selection either from the **DEUBLIN** facility or in the field by one of our representatives, short-term delivery of all selected components and, finally, fast troubleshooting of any and all problems.

Lengthy machine breakdowns are a thing of the past.

A broad assortment of unions is produced for stock and can be procured quickly. An automatic warehousing system enables all required components to be localised fast and effectively.

Lead times for special contractual products are only fractionally longer, for a modern and optimised production and assembly guarantee very short process times.

High-performance CAD systems warrant the realisation of special requirements such as the modification of an existing union or newly engineered designs. The customer receives in short notice the quotation including a technical drawing and price. The production of the rotating unions begins at that moment when the drawing has been confirmed by the customer and returned to the **DEUBLIN** facility.

Repair

Basically, all **DEUBLIN** Rotating Unions can be refurbished at the factory.

After they are returned, disassembly and cleaning begins and all worn parts are replaced with new ones. After assembly and testing, the customer receives back unions that are as good as new with an standard warranty.

When taking advantage of a warranty, the union must be returned UNOPENED. The cause of failure will be ascertained and, if so desired, the customer will receive a report for personal perusal. The result of the findings will decide whether the repair is performed on a charge or on a no-charge basis.

Numerous **DEUBLIN** products can be field repaired by the user.



For every degree of wear there is a corresponding rebuilding or repair kit available. These kits can be ordered at the **DEUBLIN** facility complete with their respective repair instructions (refer to Main Catalogue page 5).

Sealing

Original rotating unions used the media pressure to maintain seal contact. Logic indicates that as pressure increases, so do the forces holding the seals together - more pressure = tighter, better sealing.

This is why they were called “pressure joints”.

However, more pressure on the rotating seal face also meant more friction, higher torque and more wear. The resulting service life was not satisfactory.

DEUBLIN was aware of the disadvantage and applied “Balanced Mechanical Seal Technology”, a decisive improvement.

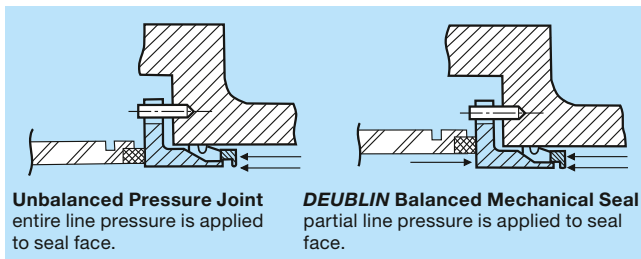

This simply means the load or pressure on the seal faces is kept to a minimum regardless of media pressure, resulting in a freer turning union and in longer seal life.

Optimal balance ratio allows for a thin film of “lubricating” media between the seal faces.

In order to attain sealing in a non-pressurised system, the floating seal contact is maintained by the spring pressure (refer to sketch).

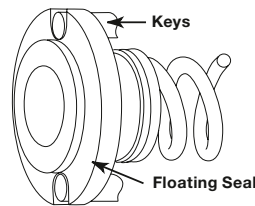

Keyed Floating Seal

Manufacturing

The entire **DEUBLIN** product range is manufactured at the cutting edge of technology from the very first drawing to the final production. Modern CNC machining centres transform highest quality materials into precision components. Cost-effective production is achieved by applying new technology and the most modern equipment.

Once assembled **EVERY** rotating union is dynamically pressure-tested for leakage as part of the final inspection procedure prior to despatch.

The core of a rotating union is the seal combination. Seal faces manufactured from tool steel, carbon graphite, bronze, ceramic, tungsten carbide or silicon carbide are micro-lapped to a surface finish of 0.025 RMS and an optical flatness of 2 light bands.

To ensure the above specifications the near perfect flatness is tested under mono-chromatic light (refer to picture).



Micro-Lapped Seals



CNC Machining Centre

Which **DEUBLIN**[®] Seal Technology?

DEUBLIN offers five different seal technologies, in order to provide the best solution for every machining application. Only **DEUBLIN** can offer such flexibility to the machine tool designer.

Closed Seal: As the name indicates, the seals stay closed with or without coolant pressure. Unions



with closed seals have only minimal “weeping” of media to allow lubrication of the seal faces. Therefore, drain lines generally are not required.

Closed seal unions generally are less affected by extremely contaminated coolant than other designs. However, closed seal unions should not be rotated for an extended time if coolant fluid is not present.

Controlled Leakage: The opposite of closed seals, controlled leakage seals always have a small gap between the seals, even when pressure is applied. For this reason, controlled leakage unions are excellent for high-speed applications with pressurized dry air. Controlled leakage unions generally are not suitable for coolant fluid applications.



Pop-Off™: This kind of seal closes only when pressure is applied. When pressure is removed, the seal faces separate by a very small distance. This eliminates friction and seal wear during operation without coolant, and therefore allows unlimited “dry running” at high speeds. Pop-Off™ designs should be considered when machining will occur with and without through-spindle coolant (TSC). Because the seals separate during tool changes, when coolant pressure is off, residual



coolant in the supply hose and spindle can drain through the seal faces. Therefore, a Pop-Off™ union generally requires a downward-pointing

drain line to direct such residual coolant into the sump. Also note that Pop-Off™ unions are not

intended for extended operation with pressurized dry air.

AutoSense™: The latest in a series of **DEUBLIN** innovations, this technology combines the best features of Pop-Off™ and controlled leakage designs. Like Pop-Off™ designs, AutoSense™ seals close when coolant pressure is applied to contain the coolant fluid, and “pop” apart in the absence of coolant pressure to allow unlimited dry running. Like controlled leakage designs, AutoSense™ seals handle pressurized dry air by creating a microscopic gap between the seal faces. AutoSense™ unions handle coolant, MQL, and dry air, by sensing the kind of media and automatically changing seal operation in response. As with Pop-Off™ seals, a drain line generally is required.



All-Media: This technology gives the machine designer complete control over seal opening and closing. By controlling the how pressure is applied to the union’s multiple connections, the machine designer can cause the seals to separate when necessary (for example, to transfer pressurized dry air) or close when appropriate (to transfer coolant fluid or oil mist). A drain line generally is required.



You will find further information in our Catalogue for Machine Tools, Machining Centres and Transfer Lines.

Operating Principles of Rotating Unions

Advantage of Through-Spindle Coolant

Nearly all modern machine tools and machining centres are equipped with coolant supplies, because high-speed cutting tools require both cooling and lubrication to reduce the rate of tool wear and to prevent overheating, which degrade the tool's strength.

A flood (or external) coolant system (**fig. 1**) cannot fulfill this task effectively, instead, coolant has to be transferred through spindle and tool directly to the cutting edge (**fig. 2**). To get there, a rotating union is needed as a junction between spindle and coolant supply.

Compared to flood coolant systems, through-spindle-coolant (TSC) pays for itself in terms of lower operating costs for tools and coolant. Better control of tool overheating also allows faster feed rates, higher productivity and higher surface quality.

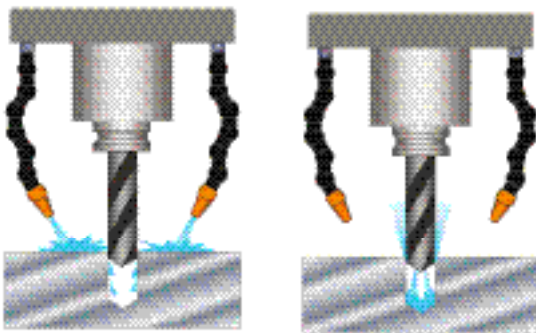

fig. 1

fig. 2

How Rotating Unions Work

A rotating union is a precision mechanical device used to transfer coolant fluid or media from a stationary source, such as a pump, into a rotating device, such as a spindle with cutting tool. The typical coolant fluid is water-based, consisting of approximately 85–95% water for cooling, 2–12% oil for lubricating the cutting edge. Small volumina of other chemicals stabilize the emulsion, counter bacterial growth and much more. Suitable rotating unions also can transfer air/oil mist, known as Minimum Quantity Lubrication (MQL), cutting oils, and even dry air.

In certain machine tool applications, rotating unions also are used to transfer hydraulic fluid or air for clamping or sensing.

Parts of a Rotating Union

As shown in **fig. 3**, a typical rotating union consists

- of a rotor that spins at the same speed as the machine tool spindle,
- a non-rotating element that closes precisely against the rotor,
- a housing that connects the supply hoses to the non-rotating element, and
- seals that contain the coolant fluid.

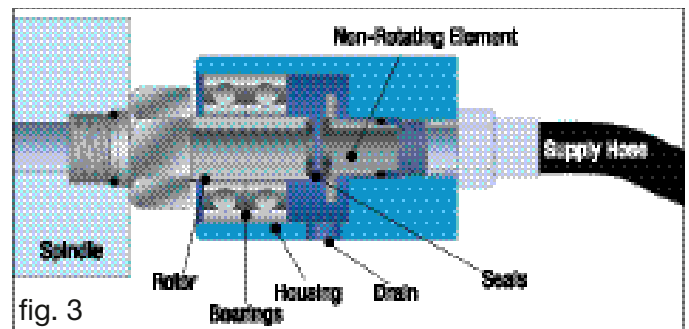

fig. 3

Bearing-supported unions connect the rotor to the housing with one or more bearings. Referring to their name “bearingless unions” do not have own bearings, they use the bearings of the spindle.

Seals are the heart of the rotating union. They must contain very high pressures while rotating at very high speeds. At 20,000 rpm, for example, the seals are moving at a relative speed of nearly 16 feet per second (5 metres per second), while containing 2,030 psi (140 bar) of fluid pressure!

For positive sealing, smooth rotation, and long service life, it is important to manufacture seal pairs from highly wear resistant materials and have them rotate on each other with the least possible surface roughness.

Additionally a state-of-the-art rotating union is designed with balanced mechanical seals. With this technology seal contact pressure and thrust load on the spindle are minimized, regardless of operating pressure.

Rotating Unions with bearings or bearingless?

Bearing-supported unions are easy to install and replace, because of their one-piece design. One distinguishes two different mounting styles. The rotor-mounted style attaches to the spindle with a threaded rotor (**fig. 4**). The bore-mounted (**fig. 5**) style slides into a precisely machined counterbore at the end of the spindle. Advantage of both styles is that any leakage is channelled by the housing into a drain line. A further advantage is that rotor-

mounted, bearing-supported unions absorb all axial forces (thrust load) on the spindle caused by coolant pressure. For both bore-mounted and bearingless unions, however, coolant pressure creates a certain thrust load on the spindle.



fig. 4



fig. 5

Bearingless unions (**fig. 6**) provide the machine tool designer with several advantages. First, eliminating bearings allows an increase in maximum rpm. Second, since only a small rotor is directly attached to the spindle, there is no possibility for the union's housing to be a source of vibration. Third, without bearings the union is immune to side loading from, for example, too much tension in the coolant supply hose. Fourth, bearingless unions can be very small, ideal for applications with multiple, closely spaced spindles. However, bearingless unions must be installed in two pieces – the rotor and a small housing containing the non-rotating element and connection to the coolant supply.



fig. 6

No matter to bearing-supported or bearingless, rotating unions remain a subject to wear besides all high-technology, because a rest of friction still remains (it is technically impossible to reduce surface roughness to zero).

Thus somewhere also a high-quality component will reach the technically limited end of its service life.

To really achieve the mere technically limited service life in daily routine, surrounding conditions should match as well.

At first the position of drain lines:

In the machine tools and processing centres range, "mixed operation" is usual and rising: Use of coolant, dry processing, compressed air during stoppage or rotation, minimum quantity lubrication.

Not always will these requirements appear in combination, but suitable products for all cases are available at **DEUBLIN**.

Rotating unions such as POP-OFF™, AutoSense™ or "All-Media", which are suitable for these procedures, separate the seal faces, if no medium pressure is applied and or adjust the distance between the seal faces in conformity with the medium.

Of course, the tool change will take place in depressurized condition, and as the mechanical seals are separated at this moment, the coolant drains off the supply lines and spindle through the opened seal faces.

As the law of gravitation also applies to rotating unions, drainages should always point downwards in order to carry away any leakage quantity properly (**fig. 7**). Actually this goes without saying, but installation positions with drainage partially or steadily pointing upwards have already been detected (**fig. 8**).



fig. 7



fig. 8

This improper connection causes stagnant leakage quantities to flood the bearings or impurities in the medium can deposit inside the rotating union in case of downtime. If these mistakes can be avoided, the rotating union "will be grateful" and supply a longer service life.

Secondly the maintenance of coolants:

Rotating unions of high quality are designed in a way as to largely resist various impurities in coolants occurring in most of the production plants. In order to obtain a long service life and maximum productivity of the rotating union, the coolant is to be filtered according to ISO 4406:1999 Code 17/15/12, SAE 749 Class 5 or NAS 1638 class 8, maximum particle size 60 μ (fig. 9).

Comparison: Pumps (fixed piston as well as variable volumes) normally require coolant filtration according to ISO 4406, Code 16/14/11 or better – in other words: They only tolerate half as much contamination.

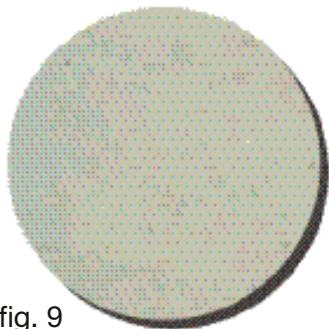

fig. 9

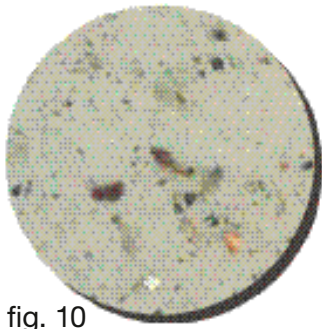

fig. 10

Only distilled water should be used for coolant preparation. Calcium and magnesium salts in tap water reduce the service life of coolants by displacing the chemicals in the coolant and breaking down the oil-water emulsion. Furthermore, they advance the growth of bacteria (fig. 10). These salts may also cause deposits inside the rotating unions resulting in premature failure. Rule of thumb: Each additional hardness degree (equivalent to 17 ppm or 17 mg/l calcium carbonate) increases the annual coolant consumption by 1%. Suitable maintenance of the coolant further increases the service life of the tools and improves the surface quality of the work pieces.

It is to be highlighted here that the maintenance of the coolant is **NOT** a requirement for the operation of rotating unions – but the user risks a reduced service life of the component.

As shown by the study of a renown car manufacturer, the “rotating unions” and/or their failure were the “most frequent” root cause for the failure of a motor spindle in different factories (flooding of spindle/damage of bearing). After having excluded a batch problem, the actual reason of the premature failure of rotating unions was investigated and it was detected that the filtration of the coolant of the respective machining centers was out of order. This is why chips penetrated the sealing faces of the rotating union and destroyed them due to abrasion. Accordingly, the failure of the rotating union

was only an indirect reason or the visible symptom for the downtime of the machining center.

After replacement of the filter and control/monitoring of the coolant filtration, the rotating unions reached their service life expected under technical aspects and exceeded it by far. At the same time, the repair costs for failed motor spindles decreased by about 75%.

In the above costs, only the change in repair costs was considered but the costs of the machine downtime have not yet been included.

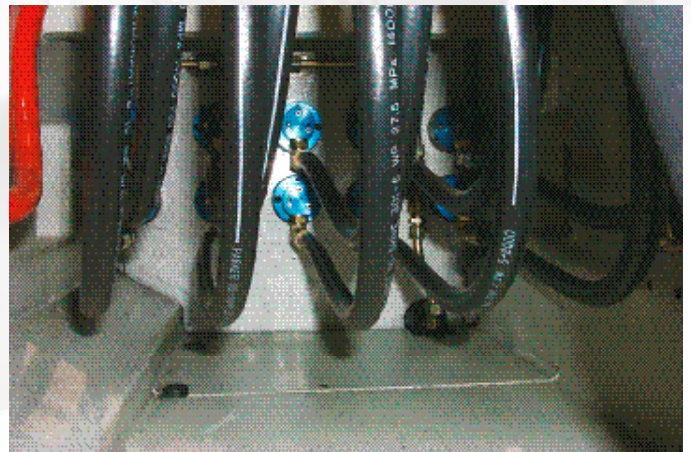
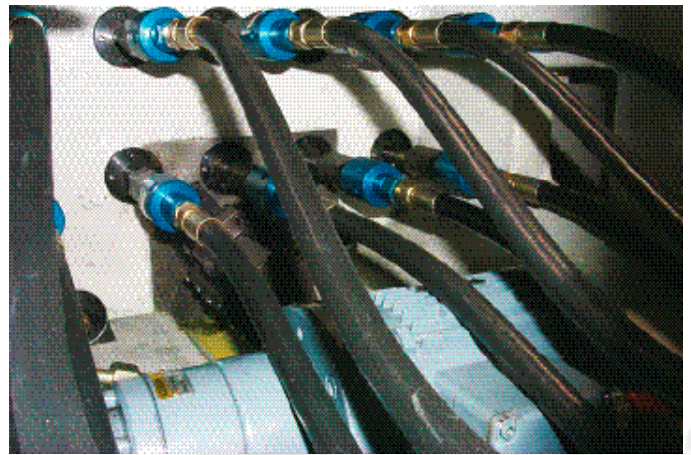

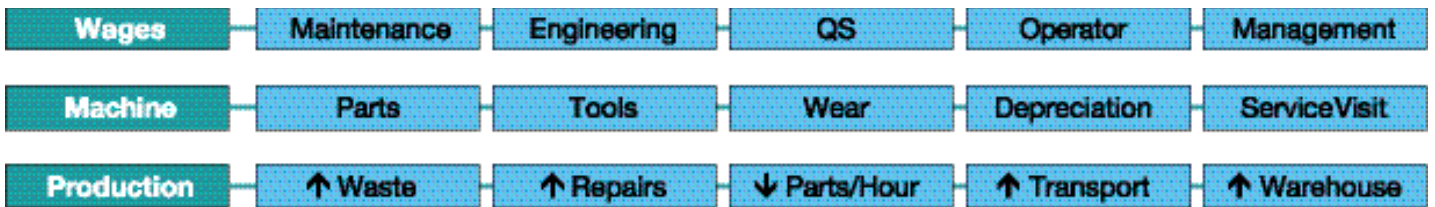

fig. 11

Consideration of machine downtime costs

In addition to the failure of a rotating union by penetration of chips as described above, failures of the solenoid valves, problems with the hydraulic pump and linear gears, defective signal transmitters or control signals may cause machine downtimes.

All reasons result in considerable costs regarding personnel, machine and production (see fig. 11). For comparison: About 15 years ago, the estimated costs for the downtime of a CNC machine amounted to € 200.00 to € 600.00 per hour.

Due to the arrival of lean production and the stronger interdependencies resulting therefrom, today these costs amount to € 2,000.00 to € 4,000.00 per hour, with an upward trend. And if other processes are affected thereby, the costs may quickly reach more than € 100,000.00 per hour.

Review the effects in your own production, but it can be second-guessed that a total-cost-of-ownership consideration which includes these costs can only arrive at the following conclusion: The purchase of high-quality components, the correct installation and maintenance of the coolant may be minor cost drivers at the beginning, but they entail considerable cost benefits over the entire service life.



You will find further information in our Catalogue for Machine Tools, Machining Centres and Transfer Lines.



Instructions of Hose Installation and Assembly of *DEUBLIN* Rotating Unions

Example Rotating Union 55/57 Series

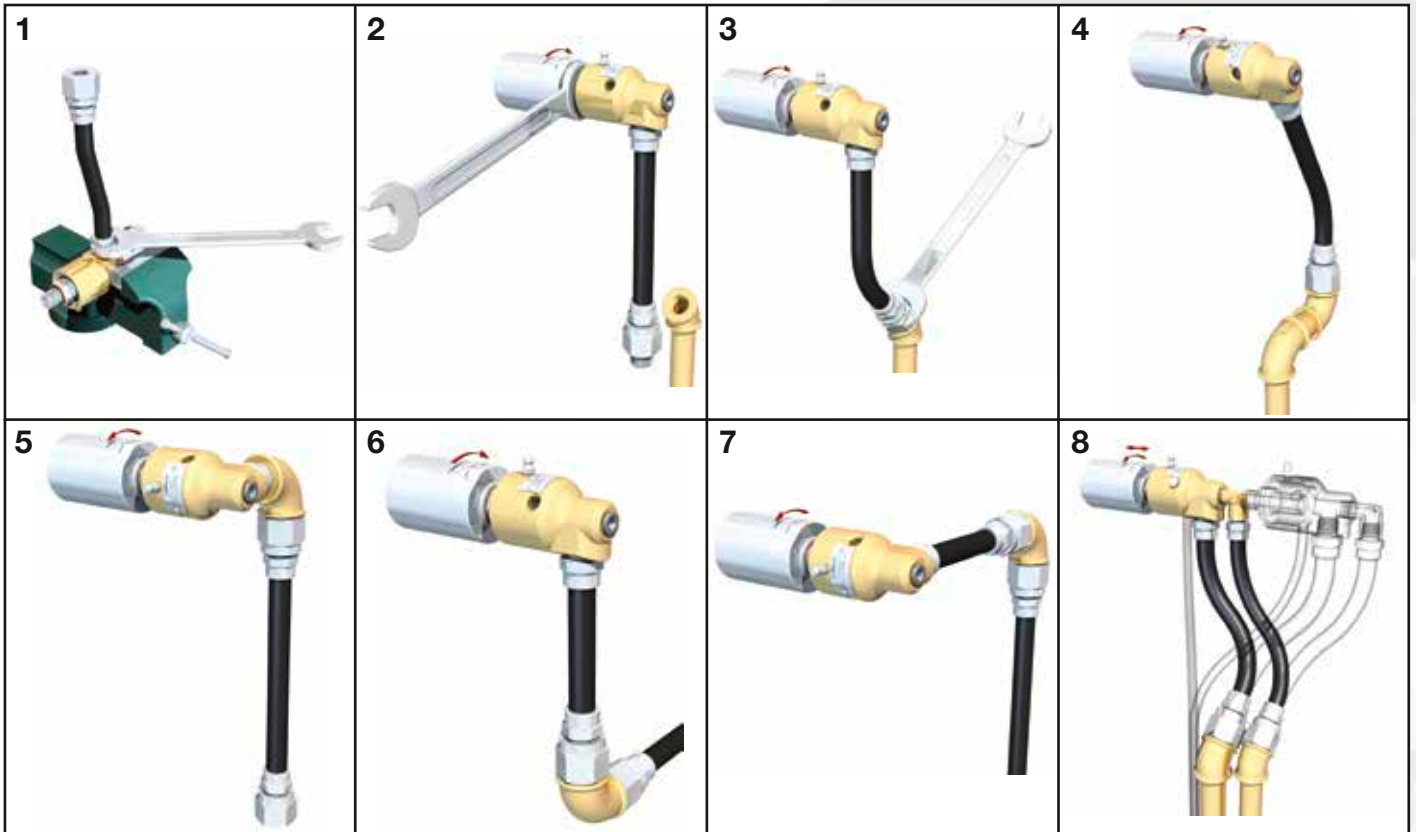

Example Rotating Union 1109 Series

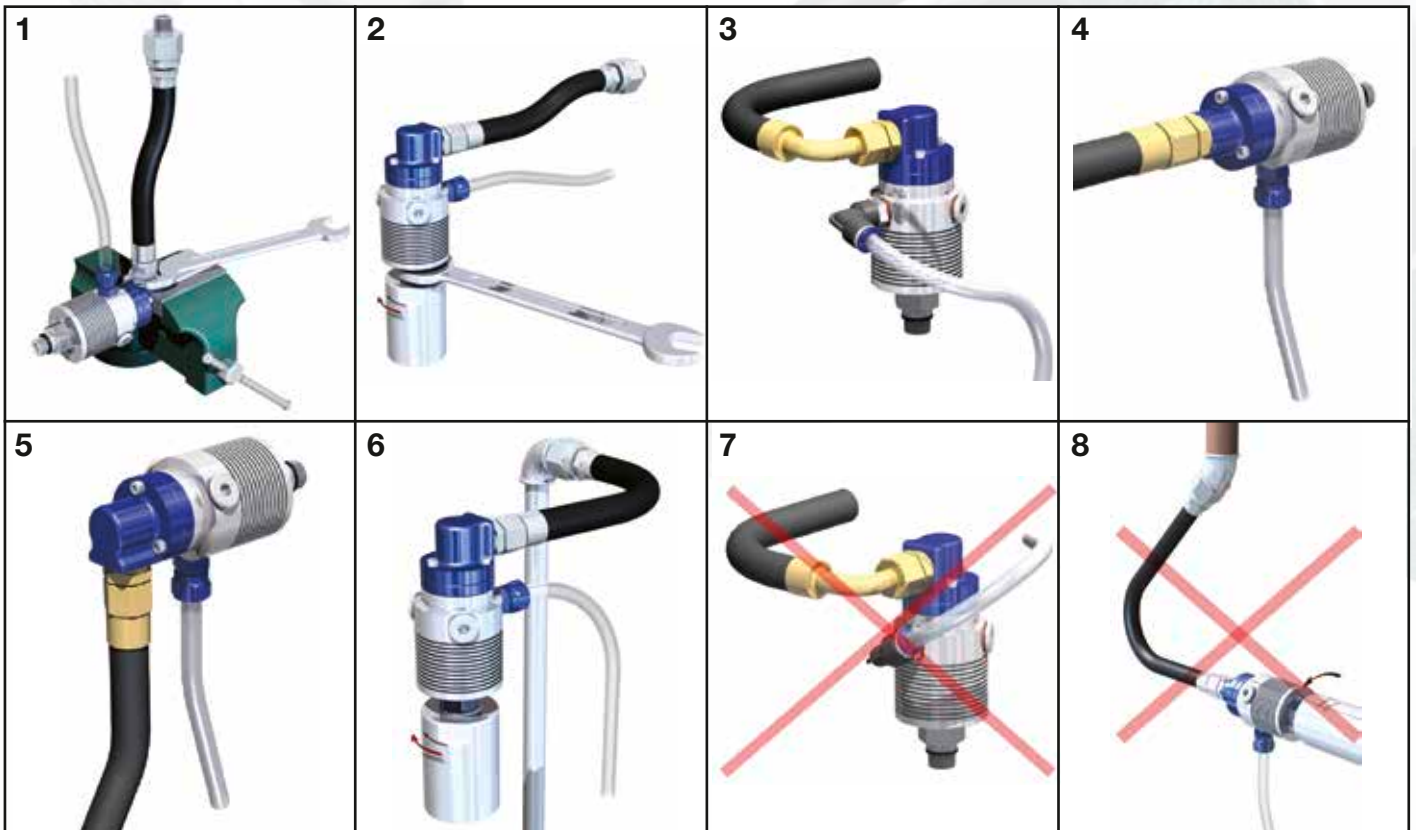

The position of the supply lines and drainage as well as their influence on the efficiency and service life of a rotating union

In case of all rotating unions based on the technology of the “balanced mechanical seal”, even those with permanently closed mechanical seals, minimum quantities of the transported medium can be found between the seal faces. They are useful for lubrication and help to avoid damages by dry run.

Despite their high technology, rotating unions are wear parts; accordingly a certain quantity of leakage can be used as indicator for the condition of the mechanical seal.

As the law of gravitation also applies to rotating unions, drainages should always point downwards in order to carry away any leakage quantity properly. Actually this goes without saying, but installation positions with drainage partially or steadily pointing upwards have already been detected.

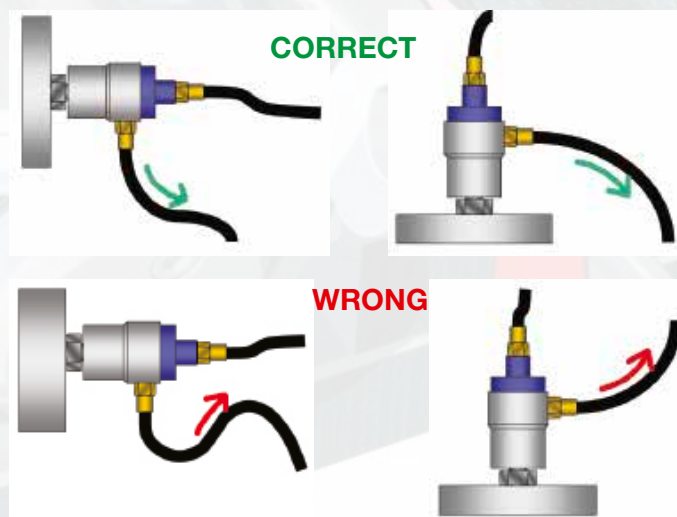

This improper connection causes stagnant leakage quantities to flood the bearings or impurities in the medium can deposit inside the rotating union in case of downtime.

Both factors reduce the service life of a rotating union considerably!

In the machine tools and processing centres range, “mixed operation” is usual: Use of coolant, dry processing, compressed air during stoppage or rotation, minimum quantity lubrication.

The rotating unions such as Pop-Off™, Auto-Sense™ or “All-Media”, which are suitable for these procedures, separate the seal faces, if no medium pressure is applied and or adjust the distance between the seal faces in conformity with the medium.

Of course, the tool change will take place in de-pressurized condition, and as the mechanical seals are separated at this moment, the coolant drains off the supply lines and spindle through the opened seal faces.

This fact cannot be influenced, but the lost quantity of the expensive coolant: By guiding the supply lines downwards, as in case of the drainage.

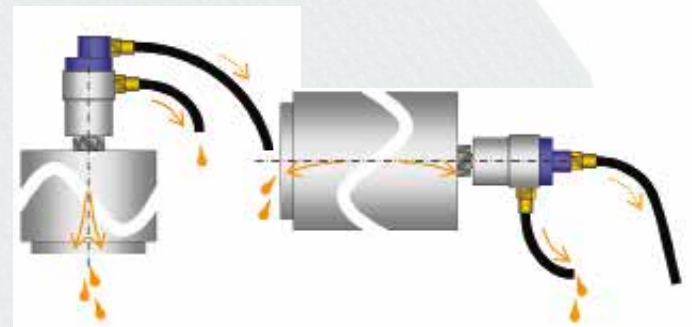

Thanks to these small tricks, the entire quantity of coolant remains between the rotating union and the on-off valve in the line and is available for the next processing operation; only a minor quantity between the rotating union and the tool tip is lost.

As opposed to lines guided upwards from the rotating union: The figure shows that the entire quantity of coolant drains off between the on-off valve and the rotating union. The leakage quantity from the spindle bore hole and the drainage is increased thereby.

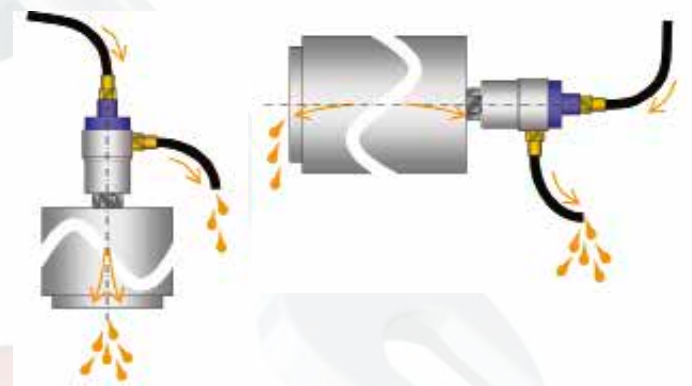

Correct installation extends service life of rotating unions! part 1

Rotating unions are used to convey various media into and through rotating machine parts. Media such as water, hydraulic or thermal oil, compressed air, vacuum, coolants etc. can be conveyed.

In case of current rotating unions, sealing between the rotating element, “rotor”, and the stationary part, “stator”, is almost always realised by mechanical seals with the respective technical finishes.

Despite extremely precise production and use of highly resistant materials, each rotating union is subject to wear which is inevitable due to its function.

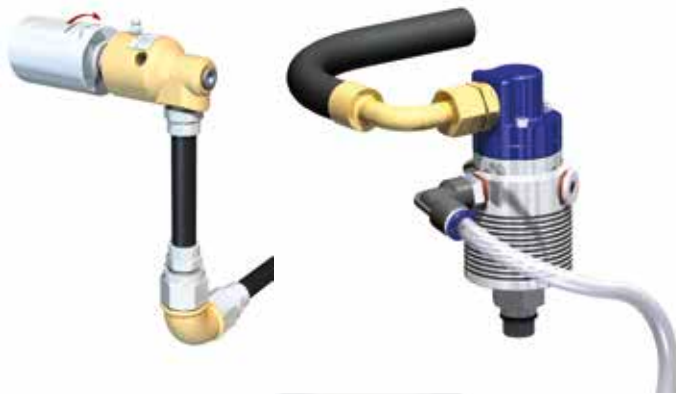

Irrespective of the technical parameters limiting the service life of a rotating union, such as speed, pressure, temperature, flow, volumes and flow velocity of the media, further factors influence the service life considerably.

Accordingly, the mounting process is also a main factor for the service life of a rotating union. Due to their bearing, it is important that it can easily be rotated in mounted condition without any warping. Improper hose length or screwing parts may cause warping of the bearings already at this stage.

In particular the installation of the hoses is very important. The main aspect: First the flexible hoses are to be attached to the rotating union and then it is connected to the shaft end by screwing at the prescribed torque. When connecting the flexible hose to the solid pipe, avoid twisting of the hose. – Never connect the rotating union to a solid pipe. These hoses are to be laid as a bow and without torsion and to be connected to the stationary pipe in a pressure-tight way. A rotating union is to be connected to the machine part also in a pressure-tight manner while the torques prescribed by the

manufacturer must not be exceeded. It is further important that the retainer for the rotating union is free from burr or chips.



If required, the drainage must always be laid downwards (at least 15°) and with a free cross-section which is as large as possible. In case of a rotating union installed vertically, the drainage must be guided downwards; in case of a rotating union mounted horizontally, the vent for controlled leakage must point down, metaphorically speaking in “6 o’clock position”.

If the drainage is located higher than the vent, the rotating union would be flooded by the occurring leakage causing an improper operating mode.

Normally, the above mentioned items as well as the observance of the mounting order should be a matter of course, but in practice, some users are obviously looking for “alternative assembly”, as can also be seen from the pictures.



Instead of wondering about the “short” service life, the user should have “listened” to his rotating union immediately after the initial operation. It quickly reveals that the installation position is not correct.

If it runs untrue or tumbles, the concentricity is not within the tolerance – a sign for wear of the screw thread or a mounting failure.



The rotating union causes noises by vibrations or is hot in the area of the bearing. This again indicates that there is warping caused by the installation and that the rotating union does not run freely.

If these failures are eliminated immediately (or even not made), the user benefits from an extended service life based on the parameters of the application without any disturbance resulting from assembly.

Then the precision “rotating union” operates highly effective and helps to reduce machine downtimes and maintenance costs in most cases.



Wrong! The leakage line goes upwards.



Wrong! Both unions are rigidly connected to each other.



Wrong! The union is mounted rigidly.



You will find further information in our Catalogues (refer to page 27).

Correct installation extends service life of rotating unions! part 2

Rotating unions are precision parts and feature a long service life if provided by quality manufacturers.

However, they are subject to wear; if considering merely technical aspects, their service life depends on the parameters of the application such as speed, pressure, temperature, and further parameters of the medium. This is the so-called “maximum theoretical technical service life”. Most design engineers and operators are absolutely aware of the latter.

But it is often less known that many other parameters largely affect the fact whether a rotating union reaches this maximum technical service life.

Let’s compare this to a tyre: Its service life sums up to several ten thousand or even to one hundred thousand kilometres because manufacturers of high quality tyres provide for a long durability of this wearing part. But if track and camber angle are misaligned for instance, the tyre will be subject to comparatively higher wear and not reach its maximum technical service life.

Expressed in simplified words, this also applies to rotating unions.

In the first part of our article as to this topic, we focused on the correct installation regarding position of connection and leakage lines.

In the following paragraph, we take a closer look at the installation space and installation situation affecting the maximum technical service life of a rotating union.

The topic of the installation space is tightly connected to the task of connecting flexible hoses to the rotating union; see our article “Correct installation I”.

To sum up: When using rotating unions, moments of force occur due to the medium pressure and the rotation within the system of components and machine.

On the other hand, a rotating union is to be installed in true alignment and in a smoothly running way.

This results in the requirement of a connection via flexible hoses laid correctly in a bent way, e.g. as they absorb side loads and thus prevent stress of the bearing of the rotating union.

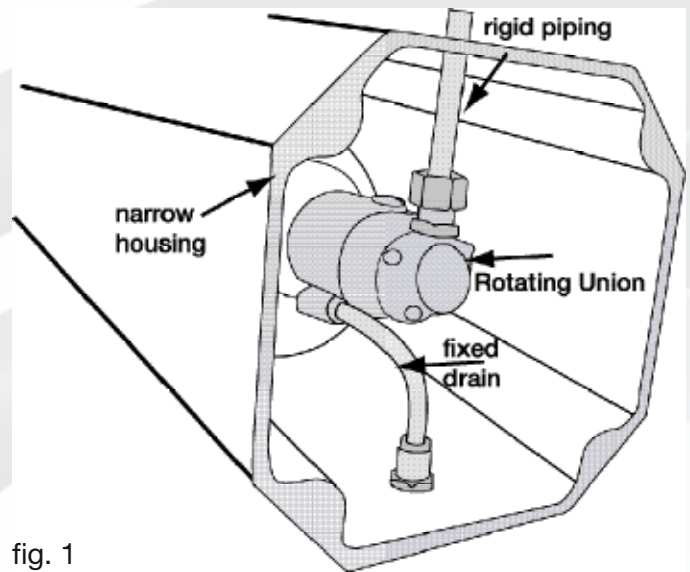

fig. 1

In reality however, rotating unions (with bearings) are often installed in a confined housing. As a result, the hose is not connected in a sufficiently bent and flexible way; sometimes it even presents an inflexible connection to the rotating union. (**fig. 1**)

The design engineer thus subjects the rotating union and its bearings to forces which it cannot withstand. These tensions reduce the maximum technical service life considerably and may even cause fatigue fractures. **Figure 2** depicts such typical marks of wear of a rotating union.



fig. 2

Paragraph 2: Installation situation

In some cases, the degree of soiling in the direct environment of the rotating union is considerable; e.g. by gummy coolants, oils (**figure 3**), or the quantity of chips as shown in **figure 4**.



fig. 3

fig. 4

For the replacement of a rotating union or installation of a new one, which is just normal for wearing parts, “the support of the rotating union has to be free from burr, chips, and soiling” as defined regarding the installation.

In the shown situations, this is hardly possible either due to the extent of soiling or the impossibility of cleaning the support in the narrow housing properly.

Above all, a design engineer should wonder whether in case of narrow housings the maintenance staff is actually able to provide for a precise alignment of the rotating union which is essential for the long, proper operation.

If not, even a high-quality rotating union cannot achieve the maximum technical service life.

Figure 5 is taken from the General Mounting Instructions and shows how the installation – in particular of rotating unions for cooling lubricants – **MUST NOT** be effected.

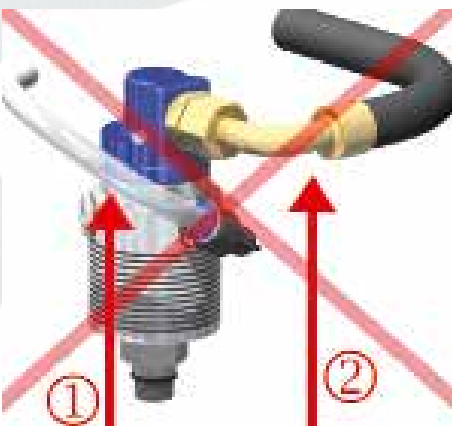

fig. 5

E.g. in case of rotating unions with Pop-Off™ technology, the mechanical seals lift if no cooling lubricant pressure is applied such as in “mixed operation” (machining without cooling lubricant /machining with cooling lubricant) or tool change.

But when lifting, the residual cooling lubricant should drain through the leakage line and follow the law of gravity (if possible!).

In case of leakage lines pointing upwards (marked with **note 1** in **figure 5**), this residue **cannot** drain away; it will thus soon go beyond the labyrinth seal, flood the bearings, and wash the grease out of the bearings. **Note 2** in this figure shows an inadmissible inflexible connection with insufficient bend radius of the line.

Despite these specifications, **exactly this** [inadmissible] way of installation exists in reality and results in the fact that a precision part fails prematurely – long before the end of the technically possible service life of the component.

Conclusion:

Today, design engineers are assigned with the important task to provide purchasers of machines with high quality and long service life.

In doing so, it is wise to consider individual components in detail also under competitive aspects as the extension of the service life of components maximises the service life of the entire machine – and ease of service and maintenance will delight the operator.

The latter is an irrefutable sales argument.

Advantage: Many manufacturers of top-of-the-range components provide the design engineer with information because teamwork maximises the operator’s benefit.

Operators and/or maintenance staff have a minor influence on the installation situation when purchasing a machine. However, they may influence the manufacturing processes by constructive complaints on the one hand.

On the other hand, operators may use their know-how in maintenance and pay attention to cleanliness, correct assembly, good alignment, and correct connection during installation to a wide extent and insofar as they have an influence on the latter.

The system of components and machine, the foreman, and the controlling department will be pleased with the achieved service life!

Contemporary rotating unions for modern printing machines

They operate in the background, but without them the functionality of modern printing machines would not be possible: Rotating unions.

Whether sheet-fed offset printing, web offset or gravure printing, rotating unions are the link between rotating rollers and the pipelines and hoses of the heating or cooling circuit for maintaining the temperature of ink application rollers, printing ink unit or dampening system.



An expert easily recognizes them due to their brass-coloured housing when the electronic unit is folded down at the side panel of the machine.

Generally speaking, temperature setting and keeping of constant temperatures in the above mentioned assemblies are a material precondition for continuous and reproducible quality at highest machine speed. This is also the key to reduction of waste paper produced during start-up or production – a cost factor which must not be disregarded.



Why is the “rotating union” that important for this task?



As it guides the medium into and/or out of the rotating part, its technology and degree of development significantly affect the efficiency of the entire machine:

- Primarily by way of optimized flow channels and reduced turbulence which also means a continuous temperature profile, i.e. increased quality with reduced waste paper.
- Secondly by considering the required energy, as modern rotating unions feature only minor pressure losses and reduced coefficients of friction so that the pump and motor rating can be lower.

In addition to the savings of costs, the reduced energy consumption also entails a reduction of CO₂, an important topic today.

Furthermore, the third aspect should not be ignored in this consideration: The service life of a rotating union.



Especially in this respect, chaff (low-cost product) is separated from wheat (branded product) quickly.

It is undisputed that each rotating union which is based on the principle of the “balanced mechanical seal” is a wear part, as the mechanical seals are subject to wear although they are lubricated by the flow medium.

One cost driver can be derived therefrom easily: How often does the service department have to replace the rotating unions? Can this be effected in the scope of the regular maintenance intervals of the machine or does it imply non-scheduled (expensive) machine downtimes?

The quality philosophy of manufacturers of branded products such as **DEUBLIN** includes that the user has to deal with maintenance as rarely as possible, i.e. **that the service life is increased.**

This, however, requires consequent materials research in order to be able to use highly wear-resistant material combinations for mechanical seals. Furthermore, a high surface quality and concentricity of the mechanical seals are to be achieved in the production process as they also immediately affect the service life.

Low-cost rotating unions often lack these features. Neither the material combination nor the surface quality or the concentricity are designed to allow the operator long intervals without maintenance.

In a total-cost-of-ownership analysis which also includes machine downtimes and (frequent) maintenance operations, the cost driver “low-cost rotating union” would stand out quickly.

But this experience can be avoided, if the machine manufacturer or the design engineer focuses on quality from the outset when developing the printing machines and if the user itself, e.g. as foreman, further pursues this focus during operation.

In the long run, cutting-edge technology pays off!

Alongside design factors that affect quality, the installation situation in the machine also plays a role. A component manufacturer can only exert influence to the extent of the information provided.

It is therefore easy to see that the longest service life of the rotating union component (those which are limited by the design or medium) can be obtained if it is operated without tension. Positional deviations and side loads on the housing cause tension and result in unbalanced loads on the bearings, and mean that the sealing surfaces of the seal contact are no longer positioned flat against each other. Damage to the bearings at an early stage is a consequence of the first situation, whilst heavy wear until the seals break is a consequence of the second.

“Tension-free operation” – key to a long service life

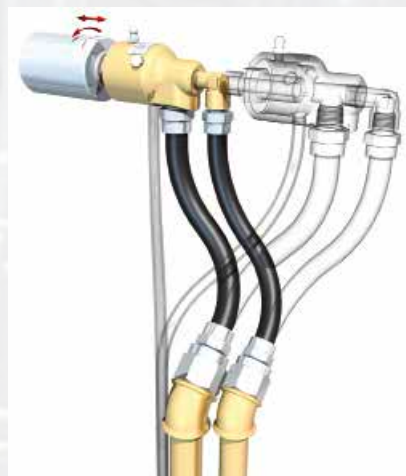

The foundations for a long service life are laid from the moment of installation through careful work, correct alignment when screwing on the rotating union, and the proper, torsion-free laying of the hose connections (as long as the

machine design engineer has provided enough space to allow for this). The claim that “every component has less space for installation because machines are more compact”, can be countered by the availability of rotating unions that are equally compact.

Knowing the importance of “a little bit of freedom to move” for rotating unions and hoses, machine design engineers can ensure that the overall machine system is operated with the highest degree of efficiency when it comes to the rotating union components.



You will find rotating unions for printing machines on pages 6 to 11 in our Main Catalogue.

Rotating unions on plastics machines – a means to an end when it comes to better quality

Example 1: Rubber products

From vehicle construction to medical technology: profiles, hoses, casings, drive belts and numerous other components are made from rubber compounds. These blends are produced using formulas which have been optimised for the particular application, even if they are all generally lumped under the designation “rubber”.

Alongside the basic formula, the mechanical engineering of the extruder plays a significant role in determining the shape and the quality of rubber products. Whereas the shape depends on the tools that are used, the quality is undoubtedly determined by the “inner values” of the extruder. These are always determined by the engineers who positively influence the quality by using improved technology.



The machine under consideration here is a cold-feed pin extruder. The required barrel extruder temperature is attained by deploying a **DEUBLIN** Rotating Union, a process that is state-of-the-art and a general precondition for maintaining technical parameters.



However, the development engineers from the extruder manufacturing company wanted to improve the quality and reproducibility of the production results. The chosen approach was to use more rotating unions.

For example, one extra rotating union was used for achieving the correct temperature for the upper and lower rotor on the gear pump. The gear pump has in itself a number of advantages when it comes to ensuring a balanced output and constant dimensional accuracy, since a material feed a short distance before the die (the tool) is much more effective than a simple feed via the barrel extruder. If the temperature of the pump is then also set, the rubber composition can be better portioned whilst the quality of the composition is also improved.

Even though heat is naturally required for extruding thermoplastic materials, there is also a point on the extruder at which a “cooler” temperature produces a better effect, surprisingly: the feed roller.

Cooler strands are more stable which means that they can be fed in more easily and are thus more consistent when fed into the extruder.

Thanks to **DEUBLIN** Rotating Unions with a shorter, more compact design, this idea became a reality. Test results show that the feed-in characteristics of the material were significantly improved. This technical approach even allows for the cooling of the needle roller bearing or the cylindrical roller bearing on the feed roller in addition.

Example 2: Plastic films

The trend towards manufacturing increasingly thinner films remains undiminished.

Three points are worth noting here.

First of all, **the reduction of resources:** the same amount of raw material results in “more end product” with a thinner film.

New polymers: material researchers are continually on the search for new materials that have a better stability in relation to their thickness.

More production output: this is partially covered by the first point, however the speed of production machines has also increased over the last years.

The first and third points have direct consequences for machine technology.

The base material is expanded through rolling and stretching until it is about to reach its physical breaking limit.



The rollers used for this process are heated using heat transfer media such as thermal oil or hot water, which increases the entropy of the molecular structure in the plastic for a short period. The material stability is reduced and the thermoplastic deformability is used to stretch the material structure.

Rotating unions are needed to transfer the required quantity of heat transfer medium to the rollers. They function as a link between the stationary feeding pipes/hoses and the rotating roller.

A significant volume of material flows through the rollers per hour, the production speed is increased, whilst the quality requirements also increase or stay the same.

This is only possible if the entire machine as a whole operates with tremendous accuracy. This applies in particular to the rotating unions, since the operational parameters - medium, pressure, temperature and speed - always affect the service life.

For this reason, **DEUBLIN** continues to develop rotating unions that are installed in plastics machines. There are versions with a short, compact design, monoflow and multiflow designs, as well as rotating unions made from stainless steel. All of these are equipped with reliable and low-wear seals as standard.

The hot media rotating unions with SAE flange are especially worth highlighting in the further development segment. Experience has shown that rotating unions are often connected to the supply hoses using adapters and screws. These connections are complex and time consuming, and often demand a great deal of exertion during installation and maintenance. They are prone to errors, even if they are installed by experienced and qualified personnel; damage may develop at a later point as a result of earlier damage to bearings or seals, which in turn lead to a reduced service life.

These problems are a thing of the past thanks to the SAE flange, as the connection points now have a new and simple design. They offer easier installation, secure sealing, increased service life and maintenance possibilities in the field.

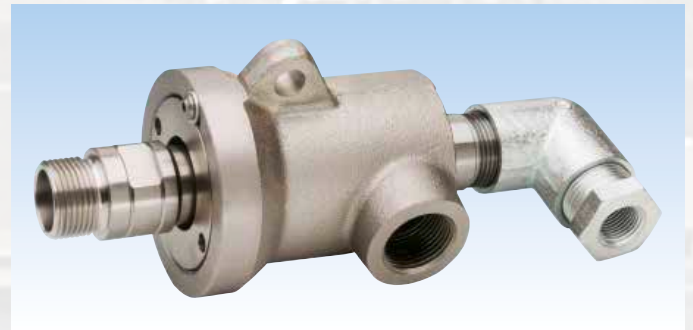

You will find rotating unions for machines in the plastic industry on pages 6 to 21, 23, 27 to 30 in our Main Catalogue.

High-pressure hydraulic rotating unions for wind turbines



Small component – big effect

Given the continuous discussions about renewable energies and despite the eroding subsidies, on-shore and offshore wind power remains in the ascendancy.

Furthermore, although the basic technology of extracting power from the wind has been known for centuries, the way power is needed today issues repeated new challenges to the designers simply because the wind is such an fluctuating source of energy.

What challenges are there?

For one, the turbines are already supposed to start at low wind speeds despite their weights. Furthermore, they are intended to be characterised by a speed that is as constant as possible over a broad range of wind forces, in order to utilise the capacity of the generator in a uniform manner.

And if the wind turns into a storm or hurricane, the rotation of the turbine blades has to be limited or, due to reasons of safety, even stopped.

For contemporary wind turbines this limiting or stopping is implemented by using so-called “pitch adjustment”, i.e. the modification of the pitch angle of the corresponding rotor blade up to deceleration or stopping.

In order to achieve the aforementioned, two central concepts oppose each other from a technical point of view: the hydraulic and the electrical pitch adjustment for rotation speed control and deceleration.

As a lay person one could arrive at the conclusion that “electrical” would be the first choice, because electrical current is produced by the generator.

However, the matter cannot be decided that easily as there are a couple of catches.

In order to provide for the required torque for today’s systems in the case of electrical pitch adjustment, correspondingly large and therefore very heavy motors have to be used. Moreover, appropriately sized batteries have to be included in case of power failure so that the turbine is provided with the torque for its primary setting and is able to re-start.

However, similar to the situation at home it applies here: The moment you actually need the battery – it is empty! Furthermore, batteries are criticised on the basis of maintenance and environmental friendliness.



In the field of hydraulics, batteries are compared to the pressure accumulator as approved component that contains sufficient reserve capacity to provide the torque required for restart in the case of power failure. A further positive aspect is that hydraulic mechanics operates in a damped mode therefore there is low wear of moving components.

The most important part, or the centrepiece of the hydraulic unit, is *the* component making sure that the hydraulic liquid is pumped from the stationary pressure accumulator into the rotating hub and reaches the adjustment cylinder: a rotating union for high-pressure hydraulics!

The requirements for this, in relation to the turbine, small component are extremely high: it is supposed to safely seal the static part from the rotating part and to guide the hydraulic medium in an equally safe manner with low maintenance requirements over many years up to decades. It is supposed to be installed easily in the case of on-site

installation. It is supposed to be made of materials to resist the adverse environmental conditions both onshore and offshore and of reaching a long service life even in the case of a degree of contamination within the medium.



The high-pressure hydraulic models of the market leader in the field of rotating unions, **DEUBLIN**, meet these requirements and make sure that turbine manufacturers and operators can be satisfied over a long period of time without concern.

The rotating unions used in this segment are based on a hydrostatic sealing principle with controlled bypass flow, in order to make sure that the sealing faces are lubricated on a permanent basis; a feature contributing to durability. They are available in single- to multi-channel designs and, depending on the model, up to 250 bar hydraulic pressure, as well as with central channel for sensor technology or connection to a slip ring.

Furthermore, as today's hydraulic systems equipped with a **DEUBLIN** Rotating Union are secured against oil leakage, there are no environmental implications.

Conclusion:

While it may well be adequate to adjust the rotor blades electrically in the case of smaller wind systems which consume power for the ramp up period anyway and do not only supply power to the grid. For larger wind mills the advantages of an autonomous hydraulic power block can be the decision making difference. And with the appropriate partner regarding the centrepiece (even for special solutions) there are no limits for both onshore and offshore from wind farms to large-scale turbines.

Practical tip:

The service life of a high-pressure hydraulic rotating union can be improved towards the "maximum possible from a technical point of view" by means of proper installation of the flexible hoses in a bend of 90° in accordance with the installation instruc-

tions and by maintaining the medium in good condition.

To the contrary, rigid piping or pulling of flexible hoses will result in lateral loads and moments of force a rotating union is not designed for. Thus, having very adverse effects on the service life.

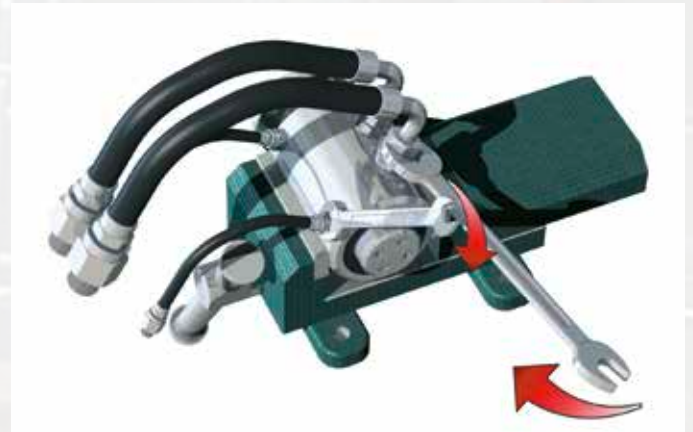

You will find rotating unions for high pressure hydraulic applications in our Main Catalogue on page 37 and in our Industry Catalogue for High Pressure Hydraulic Applications.

Rotating unions in the coil winding sector



What do soft quality steels for deep drawing, high-strength constructional steels, steels for tinplate cans, stamped parts and pressed parts for vehicles, packaging strips and springs, and electric parts or tubes/pipes have in common?

They were all strip steel coils before their final shaping process!

Even products such as PCs, notebooks, monitors, telephones and numerous others that come with plastic housings, contain a core or a supporting element made of steel - and you can be sure that almost all of those steels are derived from coils.

Bearing this in mind, there is no wonder that the annual production of hot rolled strip at just three major German sites is 15 million tonnes per year. Try to calculate the figure for the rest of Europe or even the world!



For example, if you look at a typical coil, its specific parameters may be 2 metres wide, 2 metres diameter and weighing 36 tonnes - coiled up just like aluminium foil on a household roll (please excuse this simplified comparison).

It is understandable that heavy machine technology must be used for these steel coils to coil up hot rolled strips within a period of 2 to 5 minutes. To achieve this, the coil core is clamped and rotated by hydraulic operated mandrels. Which utilise rotating unions in the centre to pass hydraulic oil with a pressure of 130 bar from the stationary supply lines to the rotating cylinder within the mandrel.

As we know, heavy weights and pressure spikes as well as continuously applied pressures are particularly wearing for the technology. Pressure spikes occur during each quick clamping/unclamping cycle, e.g. when adjusting the coil. On the other hand, pressure is maintained for a longer period of time during the holding state until the coiling process is started.

In older rotating unions there was a certain risk that the oil used for lubricating the sealing surface of the rotating union was pressed out, causing the sealing surfaces to run dry and rub against each other. This resulted in high wear, leakage and unplanned machine stops.

As “unplanned stops” are extremely expensive, it was easily justifiable for steel manufacturers to introduce the new generation of hydrostatically sealing rotating unions for high pressure hydraulic systems as soon as possible, thus ensuring the continuous lubrication of the sealing surfaces by means of a “controlled bypass flow with targeted media filtration” resulting in a long service life.

This long service life is the basis for the maintenance of **DEUBLIN** Rotating Unions fitting in with the planned routine maintenance of the system. This is the ideal state with regard to performance and costs for plant manager and controller.

This and many more advantages of **DEUBLIN** Rotating Unions for high pressure hydraulic systems such as optional one to four media passages, rotors made of hardened steel, wear-resistant bearing bushings with shaft seals for leakage chamber sealing and leakage connection for the pressure-dependent defined leakage are not only available for large steel plants. Moreover, **DEUBLIN'S** four manufacturing locations in Hofheim (German), Waukegan (USA), Bologna (Italy) and Dalian (China), offer worldwide sales and after sales service.

Also processing and finishing companies, steel trade and manufacturers where coils are unwound, recoiled or converted would benefit from the use of **DEUBLIN** Rotating Unions.

Anybody that has production machines stopped due to rotating union failure would benefit from a more reliable **DEUBLIN** Rotating Union with higher quality and functionality.

If coiler manufacturers initially install **DEUBLIN** Rotating Unions for high pressure hydraulic systems, thus creating an immediate benefit for their customers - a benefit which can be used as a convincing argument in sales negotiations!

Conclusion: If you want to maximise service life and reduce downtime and associated costs, **DEUBLIN** Rotating Unions for high-pressure hydraulic systems are the answer.



You will find rotating unions for high pressure hydraulic applications in our Main Catalogue on page 37 and in our Industry Catalogue for High Pressure Hydraulic Applications.

The new CK series rotating union has done an excellent job!

For many years, the CK rotating unions have been well-known as real “workhorse” for conveyance of heat transfer oil in the paper industry - in particular in the hot and high vibration work environment of calenders.

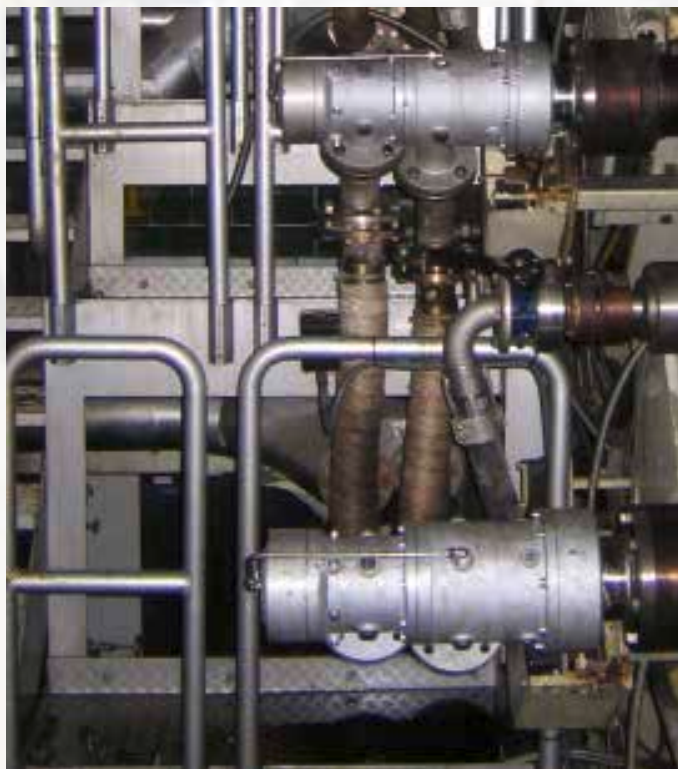

Regarding the fact that machine speed and pressure will continue to rise in future, **DEUBLIN** engineers started to redesign and upgrade the CK some time ago.

Accordingly, all bearing parts were adapted not only to operate at the familiar temperatures of 230 °C, but also with pressures up to 6 bar and speed up to 1,000 revolutions per minute (relating to 4" model).

In this enhancement the subject of lubrication/re-lubrication was also taken into account so that the models of the new CK series now feature almost maintenance-free operation.

It is now by design, that the new bearings are lubricated by the media and do not need relubrication using high-temperature bearing grease. This feature of the new CK is also called “life-time lubrication” and is an additional benefit which provides for early pay-off of the new CK and has a positive effect on the total cost of ownership (TCO).

The new CK is available with inner diameters ranging from 4" to 7" and still does not need any external cooling system.



The new CK series has been installed in numerous calenders across Europe, Asia and America, and it has proven to be a successful solution for every installed application.

When considering the TCO and not the product “rotating union” itself, the supplementary services rendered by a renown supplier such as **DEUBLIN** become the focus of attention.

In this respect, it can be noticed that the entire drying section of a paper machine often features a great potential for performance increase and/or cost reduction.

For this purpose, **DEUBLIN** examines this machine segment and develops an optimization concept for the steam and condensation system including rotating unions, suitable siphon systems, and turbulence bars which considerably improve the heat transfer.

This consulting service provides several benefits: The paper machines are fit for the future and the energy input is reduced which immediately results in lower costs and reduced CO₂ emissions.

Experience gained in this respect and information on many other relevant aspects of the paper machine can be exchanged at the annually “Paper Drying Seminar”.



You will find rotating unions for the paper industry on page 25 in our Main Catalogue and in the Product Catalogue for Rotating Unions and Siphonsystems.

DEUBLIN ATEX Rotating Unions



The ATEX certification resulted from the finding that the term “ignition source” does not necessarily relate to electric machine parts, only, but also to other mechanical machine elements which are not self-driven.

In the environment of such mechanical components, conditions may occur such as an inflammable gas-air mixture in respect of which the surface temperature of the component also presents an “ignition source” while an “electric spark” does not necessarily exist.

Accordingly, the main focus is on defining hazardous components also under the aspects of the Machinery Directive 2009 and indicating limit values beyond which the operation of the component is not admitted.

For this purpose, extensive and time-consuming tests were effected at the **DEUBLIN** site in Wallau in close cooperation with the German Technical Supervisory Association TÜV in which the compatibility of the respective rotating union models with the ATEX requirements was proven.

The ATEX rotating unions are thus classified in group II (all devices except for mining) and group 2GD (gas, dust).

The type of protection is „C“, i.e. design safety, prevention of ignition sources by application of accepted engineering rules and selection of appropriate materials in engineering and design.

The explosion group is IIB (gases and vapours: town gas, ethylene etc.) with temperature class T3 at a maximum surface temperature of the rotating union of 200 °C with an ambient temperature of 40 °C while the latter may range from +3 °C to +40 °C.

DEUBLIN AEO F Certification



During a time of advancing globalisation and increasingly-international exchange of goods, “safeguarding the international supply chain” is taking on a particular importance.

AEO is an EU customs regime granted to trusted businesses; it aims to increase security in the international supply chain whilst facilitating trade.

The principle behind this certification is to monitor companies all over the world operating on an international level and to ensure that these companies become secure market participants. According to the World Customs Organisation (WCO), this status should be introduced all over the world. It currently exists not only in the EU, but also, under a different name, in the USA and is due to be replicated in many other countries in the near future too.

Together with the secure structuring of the goods and services supply chain, the aim of the initiative is to relieve the burden currently on inspection bodies at external borders. This means that, at **DEUBLIN**, we have a right to immediate inspection when ordered and are able to apply for inspections to be carried out outside of “official locations”, so in other words at company premises instead, through a simplified procedure. In terms of security, there will be a lower amount of data that we need to transfer and, in addition, we can take advantage of simplifications in terms of customs legislation.

Despite the significant amount of work involved, as a global company, we immediately identified the benefits for customers, applied for the certification and, following successful inspection, received certification.

DPS - DEUBLIN Performance System

DPS

The *DEUBLIN* Performance System – or DPS – is based on the experiences of the Toyota Production System. Adjusted to *DEUBLIN* requirements, the aim is to implement an integrated approach towards providing the company with the capabilities to deal with the challenges of the future.

The main principle throughout the system is increasing customer satisfaction. Through constant and continuous reduction of surplus production, balancing of available resources and avoidance of non-value-adding activities such as waiting times, the entire production process is tailored to the customer's own requirements. This is how *DEUBLIN* has managed to reach a stage where a wide range of models can be dispatched within one working day.

However, the DPS at *DEUBLIN* is not restricted to the production processes; it actually comprises every company department. This way, employees in all departments are working towards the continuous improvement of all processes. Through employee development and support, a cycle of sustainable and continuous optimisation has been developed which, alongside maximum technical efficiency, also integrates framework conditions such as the protection of resources and the environment into the company philosophy. What began tentatively at the end of 2010 has developed into a real success story. We are continuing to pursue the idea of the founder of the company, Luke Deubler: "We haven't started yet".

Trainings, Seminars, Workshops etc.

Although rotating unions have been important passive machinery components for decades already, there are still large gaps in knowledge.

These do not simply concern functional issues, but also everything around installation, maintenance and support in order to achieve the maximum technical life span.

That's why *DEUBLIN* offers training courses, seminars and workshops all about rotating unions, from "basic" to "advanced" courses in a one- to two-year cycle through to target group-specific topics such as coolant and cutting lubricants and paper manufacture.

The seminars take a lateral look at rotating unions and bring together *DEUBLIN* technology providers, represented by consultants, and users.

Training courses

Training courses are only available to an exclusive group of participants and are hosted at the *DEUBLIN* company premises.

Rotating union and Coolant seminar

The original seminar takes place annually with over 50 participants, mainly from German-speaking world, but also some international guests and top-class speakers from world-renowned companies.

The subject matter mainly revolves around topics such spindle technology, cooling lubricant maintenance, filtration, micro-lubrication, etc., which effect the lifespan of rotating unions.

Perspectives are expanded upon from the field of application with relevant *DEUBLIN* knowledge with a view to rotating unions.

Paper drying seminar / paper products training course

The seminar is well-attended on a regular basis, both in terms of speakers and in terms of audience.

The title of the seminar is actually a little too short, as many more subjects concerning paper machines and production far beyond the dryer area are dealt within the presentations.

Functional models providing a descriptive insight enrich the presentations and add a truly "tangible" practical edge to the theory elements, usually resulting in vibrant discussions within the groups standing around the models.

The paper products training course takes place at interested paper manufacturers and can be tailored directly towards local projects.

Offering the highest possible product quality is, in our opinion, not enough in today's market – the product quality must be enhanced through dialogue and multi-directional knowledge transfer.

An important step towards promoting developments in all participants in order to hold one's ground in the long term in the face of international competition.

DEUBLIN Catalogues



Main Catalogue
Rotating Unions



Rotating Unions
for Machining Tools



Multi-Passage
Rotating Unions



Rotating Unions
for High Pressure Hydraulic



Rotating Unions
and Siphon Systems



Rotating Unions with
Electrical Slip Rings



Rotating Unions for
Continuous Casting Machines

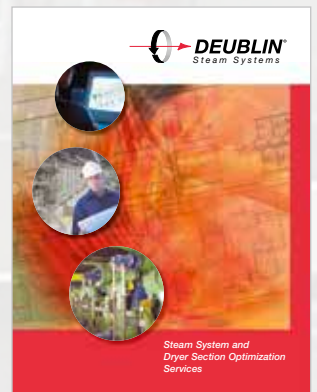

Steam System and
Dryer Section Optimization



DEUBLIN locations in 17 countries worldwide, DEUBLIN representations in 47 countries worldwide!

DEUBLIN worldwide



Since its establishment in 1945, *DEUBLIN* has consistently adhered to a policy of producing the best product of its kind in the market. The result of this policy has been constant growth through the years. For this progress we are grateful to our many loyal customers. We cordially invite you to visit our modern manufacturing facilities in Waukegan, Illinois; Hofheim-Walau, Germany; Montevoglio, Italy and Dalian, China.

Sincerely,

Donald L. Deubler
Chairman of the Board



Global Headquarters in Waukegan, Illinois, U.S.A.



Mainz, Germany



Bologna, Italy



Dalian, China

AMERICA

DEUBLIN USA

2050 Norman Drive
Waukegan, IL 60085-6747 U.S.A
Phone: +1 847-689 8600
Fax: +1 847-689 8690
e-mail: customerservice@deublin.com

DEUBLIN Brazil

Rua Fagundes de Oliveira, 538 - Galpão A11
Piraporinha
09950-300 - Diadema - SP - Brasil
Phone: +55 11-2455 3245
Fax: +55 11-2455 2358
e-mail: deublinbrasil@deublinbrasil.com.br

DEUBLIN Mexico

Norte 79-A No. 77, Col. Claveria
02080 Mexico, D.F.
Phone: +52 55-5342 0362
Fax: +52 55-5342 0157
e-mail: deublinmexicocs@deublin.com

ASIA

DEUBLIN China

No. 2, 6th DD Street,
DD Port Dalian, 116620, China
Phone: +86 411-8754 9678
Fax: +86 411-8754 9679
e-mail: info@deublin.cn

Shanghai Branch Office

Room 15A07, Wangjiao Plaza
No. 175 East Yan'an Road, Huangpu District
Shanghai 200002
Phone: +86 21-5298 0791
Fax: +86 21-5298 0790
e-mail: info@deublin.cn

DEUBLIN Asia Pacific

51 Goldhill Plaza
#17-02 Singapore 308900
Phone: +65 6259-92 25
Fax: +65 6259-97 23
email: deublin@singnet.com.sg

DEUBLIN Japan

2-13-1, Minamihanayashiki, Kawanishi City
Hyogo 666-0026, Japan
Phone: +81 72-757 0099
Fax: +81 72-757 0120
e-mail: customerservice@deublin-japan.co.jp
2-4-10-3F, Ryogoku, Sumida-ku
Tokyo 130-0026, Japan
Phone: +81 35-625 0777
Fax: +81 35-625 0888
e-mail: customerservice@deublin-japan.co.jp
1-9-2-4F, Mikawaanjo-cho, Anjo City
Aichi 446-0056, Japan
Phone: +81 566-71 4360
Fax: +81 566-71 4361
e-mail: customerservice@deublin-japan.co.jp

DEUBLIN Korea

Star Tower #1003, Sangdaewon-dong 223-25,
Jungwon-gu, Seongnam-si, Gyeonggi-do,
South Korea
Phone: +82 31-8018 5777
Fax: +82 31-8018 5780
e-mail: customerservice@deublin.co.kr

EUROPE

DEUBLIN Germany

Florenz-Allee 1
55129 Mainz, Germany
Phone: +49 6131-49980
e-mail: info@deublin.de

DEUBLIN Italy

Via Guido Rossa 9 - Loc. Montevoglio
40053 Comune di Valsamoggia (BO), Italy
Phone: +39 051-835611
Fax: +39 051-832091
e-mail: info@deublin.it

DEUBLIN Austria

Lainzer Straße 35
1130 Wien, Austria
Phone: +43 1-8768450
Fax: +43 1-876845030
e-mail: info@deublin.at

DEUBLIN France

61 Bis, Avenue de l'Europe
Z.A.C de la Malnouse
77184 Emerainville, France
Phone: +33 1-64616161
Fax: +33 1-64616364
e-mail: service.client@deublin.fr

DEUBLIN Poland

ul. Bierutowaska 57-59
51-317 Wroclaw, Poland
Phone: +48 71-3528152
Fax: +48 71-3207306
e-mail: info@deublin.pl

DEUBLIN Russia

5ya yl. Sokolinoi gori, 18, bld 2, 1st floor
Moscow, 105275, Russia
Phone: +7 495-647 1434
e-mail: info@deublinrussia.ru

DEUBLIN Spain

C/ Lola Anglada, 20 local 1
08228 Les Fonts (Terrassa), Spain
Phone: +34 93-221 1223
e-mail: deublin@deublin.es

DEUBLIN United Kingdom

6 Sopwith Park, Royce Close, West Portway
Andover SP10 3TS, UK
Phone: +44 1264-33 3355
Fax: +44 1264-33 3304
e-mail: info@deublin.co.uk



DEUBLIN products & services are available throughout the world.

www.deublin.eu

